

Electronic mixing valve with programmable thermal disinfection 

© Copyright 2020 Caleffi

Series 6000 (24 V) 

INSTALLATION AND COMMISSIONING MANUAL



CONTENTS

<i>Warnings</i>	
<i>Product range</i>	2
<i>Characteristic components</i>	
<i>Package content</i>	3
<i>Technical specifications</i>	4
<i>Operating principle</i>	5
<i>Digital regulator</i>	6
<i>Operating status</i>	11
<i>Programs</i>	12
<i>Actuation relays</i>	13
<i>Operating parameters</i>	14
<i>Log</i>	15
<i>Hydraulic installation</i>	18
<i>Maintenance</i>	19
<i>Manual opening procedure for flanged versions</i>	20
<i>Alarm management</i>	21

Function

The electronic mixing valve is used in centralised systems that produce and distribute domestic hot water.

Its function is to guarantee and maintain the temperature of the domestic hot water delivered to the user when there are variations in the temperature and pressure of the hot and cold water at the inlet or in the draw-off flow rate.

This particular series of electronic mixing valves is equipped with a **specific regulator that controls a set of programs for circuit thermal disinfection against Legionella.**

It also allows **checking that the thermal disinfection temperature and time are actually reached and means the appropriate corrective action can be taken.** All the parameters are updated every day and logged, with temperatures recorded every hour.

Depending on the type of system and habits of the user, it is possible to program temperature levels and operation times in the most appropriate manner.

It is fitted for remote control with specific MODBUS-RTU transmission protocols, for use in Building Management Systems (BMS).

WARNINGS

The following instructions must be read and understood before installation, commissioning and maintenance of the electronic mixing valve.



The safety symbol is used in this manual to draw attention to the safety instructions. The meaning of this symbol is as follows:

CAUTION!

YOUR SAFETY IS INVOLVED. FAILURE IN FOLLOWING THESE INSTRUCTIONS MAY RESULT IN INJURY.

- The electronic mixing valve must be installed by a qualified installation engineer in accordance with national and/or local regulations.
- If the electronic mixing valves are not installed, commissioned and maintained properly in accordance with the instructions contained in this manual, they may not operate correctly and may endanger the user.
- Make sure that all connection fittings are watertight.
- When making the hydraulic connections ensure that threads are not mechanically overstressed. Over time, this could result in breakage, with water leaks causing damage and/or injury.
- Water temperatures higher than 50°C may cause serious scalding. When installing, commissioning and maintaining electronic mixing valves, take the necessary precautions to ensure that high water temperatures do not place anyone at risk.



CAUTION: Risk of electric shock. The back panel and mixing valve contain live circuits. Cut off the electric supply before carrying out any work. Failure in following these instructions may result in injury of persons or damage to property.



When switching on, you will need to select the desired language from the following options:

I - E - F - D - ES - P - NL - SL - HR - SR - RO

If the language is not selected within one minute, the menu will move on to the date and time setting procedure. The language can always be changed via the "settings" menu.

Product range

6000 Series Electronic mixing valve with programmable thermal disinfection. Threaded version. _____ sizes DN 20 (3/4") - DN 25 (1") - DN 32 (1 1/4") - DN 40 (1 1/2") - DN 50 (2")

6000 Series Electronic mixing valve with programmable thermal disinfection. Flanged version. _____ sizes DN 65 and DN 80

Characteristic components

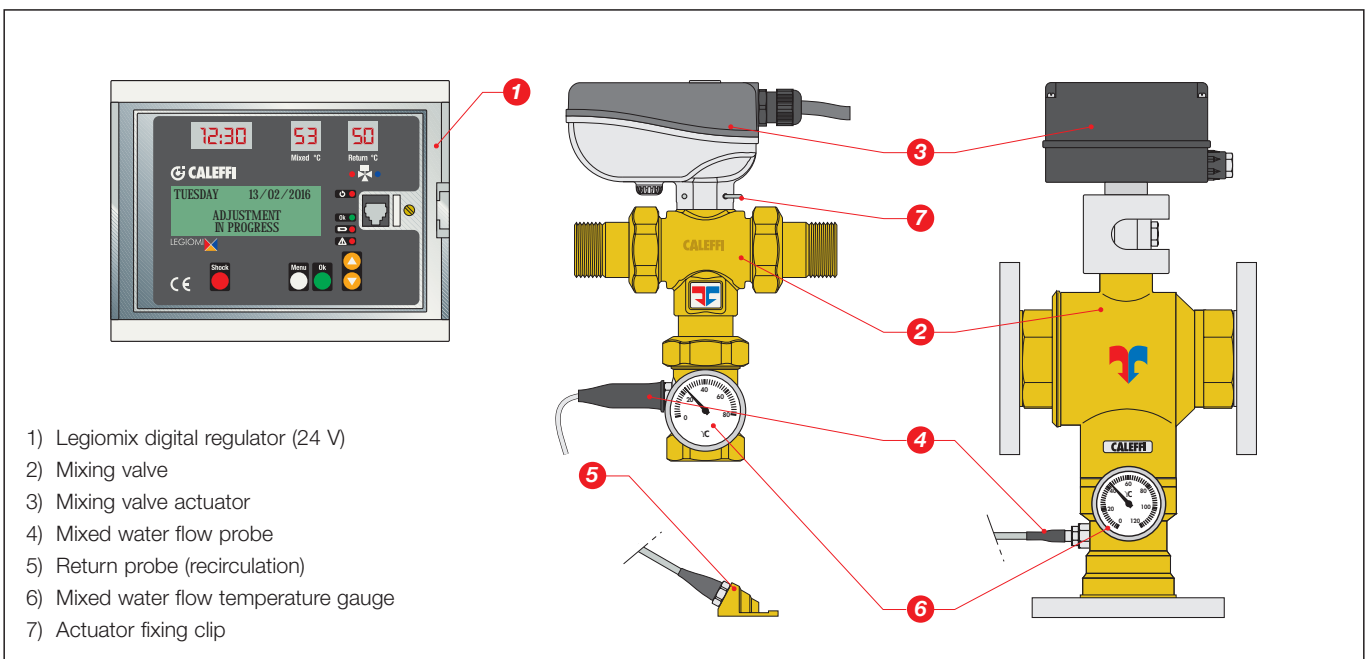

Package content

- Digital regulator, consisting of housing and base for electrical connection
- DIN bar and wall anchors
- Mixing valve
- Actuator
- Flow probe
- Return contact probe. Return probe with pocket (optional) code F69381 (not supplied as standard)
- Cable seals
 To ensure protection class IP 54, there are 9 holes in the bottom part of the housing for fitting the cable seals, as follows:

- Electric supply:	PG9	supplied already mounted
- Mixing valve control:	PG11	supplied already mounted
- Supply sensor	PG7	supplied already mounted
- Return probe (system recirculation):	PG7	supplied mounted
- 4 indicator relay contacts:	PG9	supplied unmounted
- RS485 data interface:	PG7	supplied unmounted
- Spare fuses
- Installation and commissioning manual
- Lever for manual opening (flanged versions only)

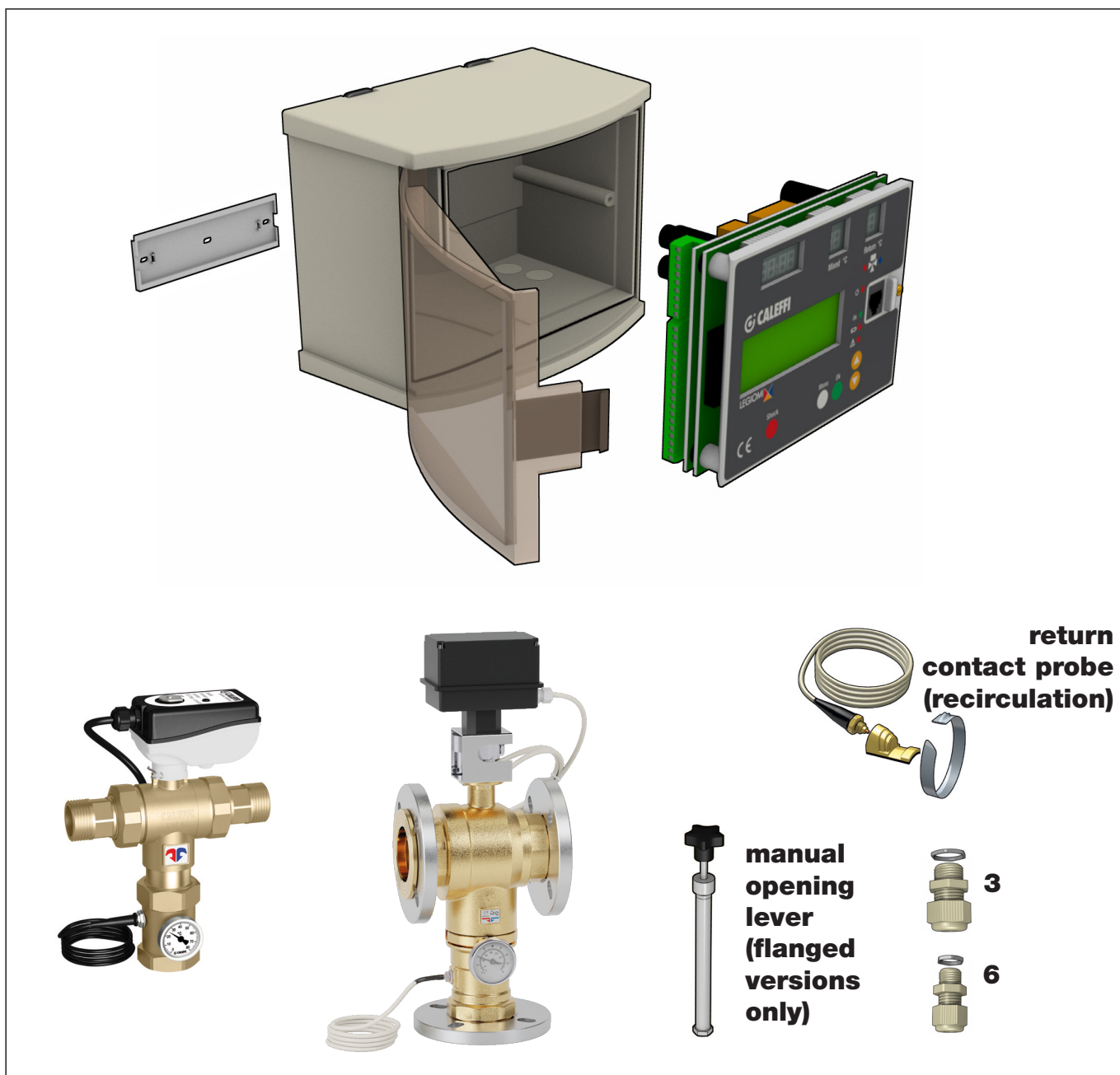

Technical specifications

Valve body

Materials:
 Body: - threaded versions: brass EN 12165 CW617N
 - flanged versions: "LOW LEAD" dezincification resistant alloy **CR** EN 12165 CW724R
 Ball: - 3/4"-1 1/4" versions: brass EN 12165 CW614N, chrome plated
 1 1/2"-2" versions: brass EN 12165 CW614N, chrome plated, POM
 - flanged versions: stainless steel AISI 316
 Hydraulic seals: threaded versions: EPDM - flanged versions: NBR

Body nominal pressure: PN 16
 Maximum working pressure: 10 bar
 Maximum differential pressure: 5 bar
 Maximum inlet temperature: 100°C
 Temperature gauge scale: 0-80°C

Hot and cold water connections:
 3/4"-2" M (ISO 10226-1) with union
 Mixed water connection: 3/4"-2" F (ISO 10226-1) with union
 Flanged connections: DN 65 and DN 80, PN 16 can be coupled with counterflange EN 1092-1

Actuator for threaded version

Electric supply: 24 V (ac) - 50/60 Hz directly from the regulator
 Power consumption: 6 VA
 Protection cover: self-extinguishing V0
 Protection class: IP 65
 Ambient temperature range: -10-55°C
 Electric supply cable length: 0,8 m

Actuator for flanged version

Electric supply: 24 V (ac) - 50/60 Hz directly from the regulator
 Power consumption: 10,5 VA
 Protection cover: self-extinguishing V0
 Protection class: IP 65
 Ambient temperature range: -10-55°C
 Electric supply cable length: 2 m

Mixing valve performance

Accuracy: $\pm 2^\circ\text{C}$
 Maximum differential pressure: 5 bar
 Maximum ratio between inlet pressures (H/C or C/H) with $G_{\min} = 0,5 \text{ Kv}$: 2:1

	DN 20	DN 25	DN 32	DN 40	DN 50		
Size	3/4"	1"	1 1/4"	1 1/2"	2"	DN 65	DN 80
Kv (m³/h)	8,4	10,6	21,2	32,5	41,0	90,0	105,0

Digital regulator

Material: self-extinguishing ABS, white RAL 1467
 Housing: self-extinguishing SAN, smoked transparent
 Cover: self-extinguishing SAN, smoked transparent
 Electric supply: 24 V (ac) 50/60 Hz
 Power consumption: 6,5 VA
 Adjustment temperature range: 20-85°C
 Disinfection temperature range: 40-85°C
 Ambient temperature range: 0-50°C
 Protection class: IP 54 (wall mounting) (Class II appliance)
 Contact rating: 1A / 24 V
 Mixing valve control: 5(2) A / 24 V
 Alarm relay (R2): 10(2) A / 24 V
 Relay 1, 3, 4:
 Fuses: 1 (main): 400 mA
 Fuses: 2 (mixing valve): 1 A
 Charge reserve: 15 days in the event of electric supply failure, with a 3-cell rechargeable 150 mAh buffer battery
 Enabled by microswitch.
 Battery recharging time: 140 h
 Conforms to Directives: CE

Temperature probes

Material: stainless steel
 Body: stainless steel
 Type of sensitive element: NTC
 Working temperature range: -10-125°C
 Resistance: 10000 Ohm at 25°C
 Time constant: 2,5
 Max. distance for flow or recirculation probe: 150 m cable 2x1
 250 m cable 2x1,5

RECOMMENDED flow rates to ensure stable operation and an accuracy of $\pm 2^\circ\text{C}$

	DN 20	DN 25	DN 32	DN 40	DN 50		
Size	3/4"	1"	1 1/4"	1 1/2"	2"	DN 65	DN 80
Min (m³/h)	0,5	0,7	1,0	1,5	2,0	4,0	5,0
Max (m³/h)*	10,3	13,2	28,1	39,0	48,3	110,0	150,0

* $\Delta p = 1,5 \text{ bar}$

Operating principle

At the inlets the mixing valve has the hot water from the storage and the cold water from the water mains. At the outlet there is the flow mixed water. By means of a specific probe, the regulator measures the temperature of the mixed water at the valve outlet and actuates the mixing valve in order to maintain the set temperature.

The appliance has a built-in digital clock, which can be used to set anti-legionella programs to disinfect the water system.

The system is disinfected by raising the water temperature to a specific value for a specific time duration.

For **the best thermal disinfection control**, in this type of system it may also be necessary to measure the temperature of the water returning from the distribution network, **using the recirculation probe**. When this measurement is available, it is used to check and **control the temperature reached over all or part** of the network, since the probe may be located at a significant remote point of the system.

The appliance is equipped with an **RS-485 interface with MODBUS-RTU protocol for remote querying and setting and it carries alarm signals and controls for other system devices outside via specific relays**.

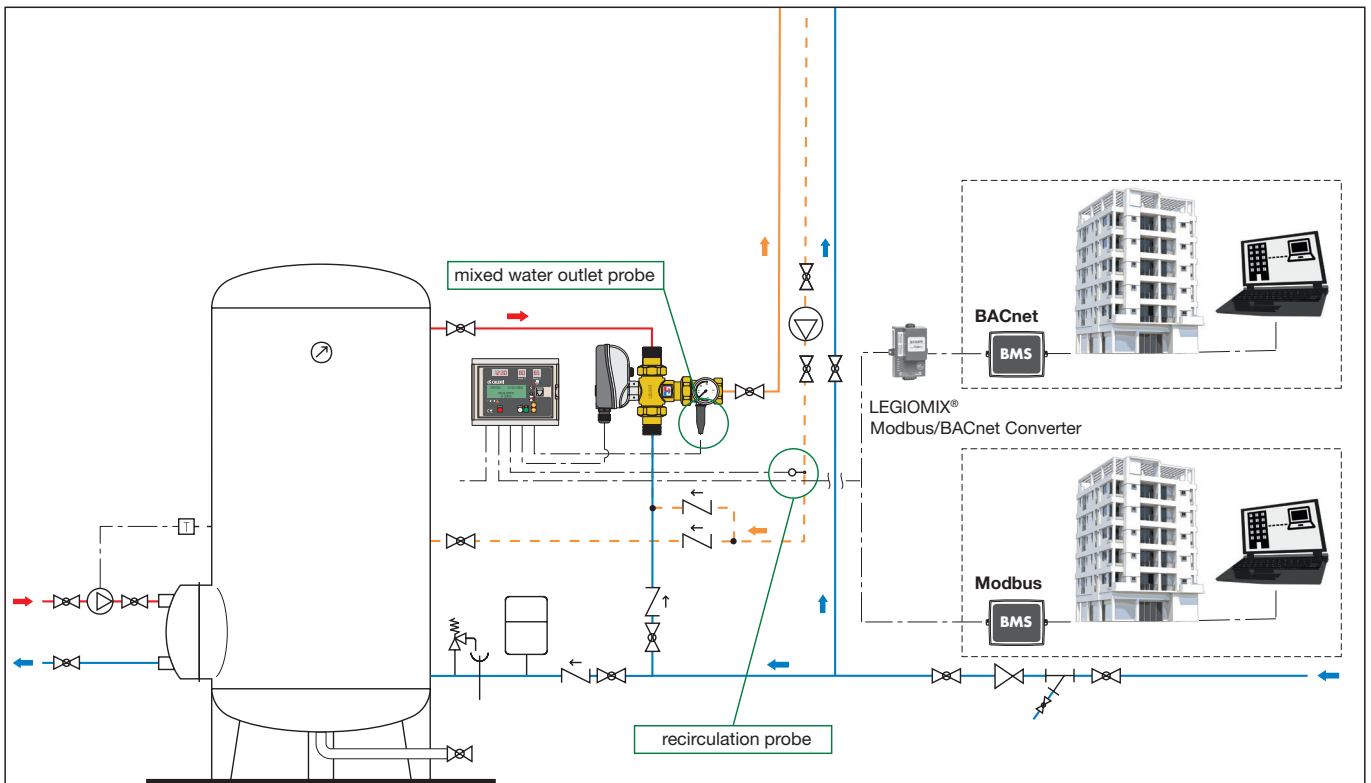

A MODBUS-RTU / BACnet interface converter, code 755052, is available as an accessory for use in BMS which communicate with the BACnet transmission protocol



Digital regulator

Electrical connections

Before connecting the power supply, enable the battery by means of the specific microswitch, so as not to activate the alarm signal.

To remove the electrical wiring base, turn it round and extract it from its housing.

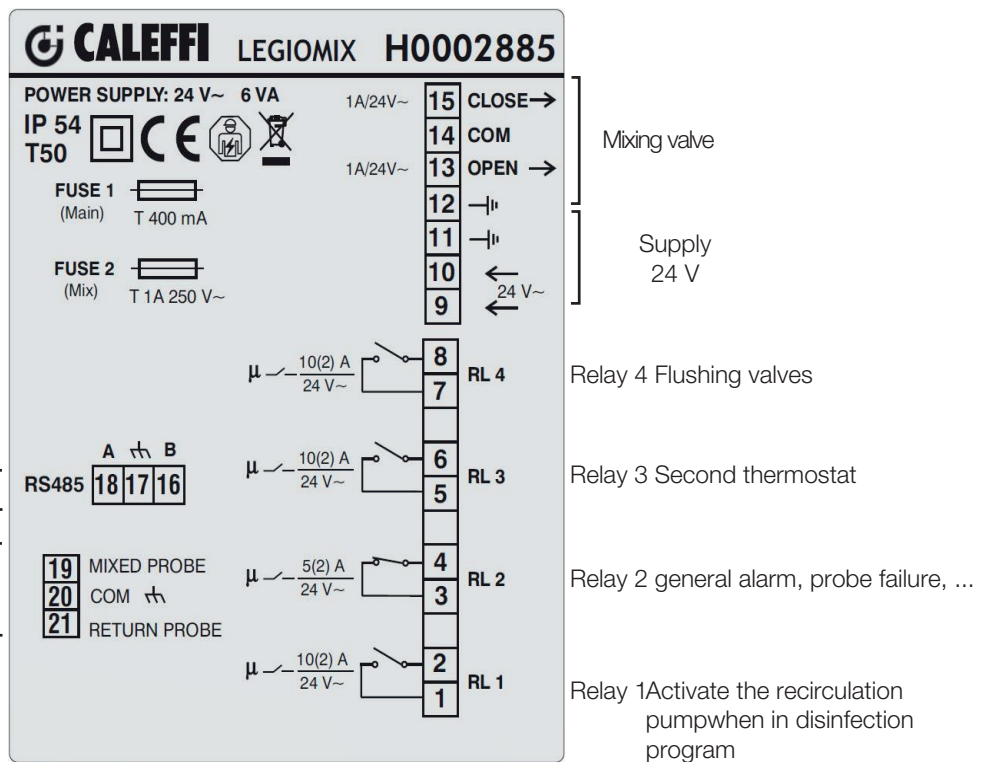
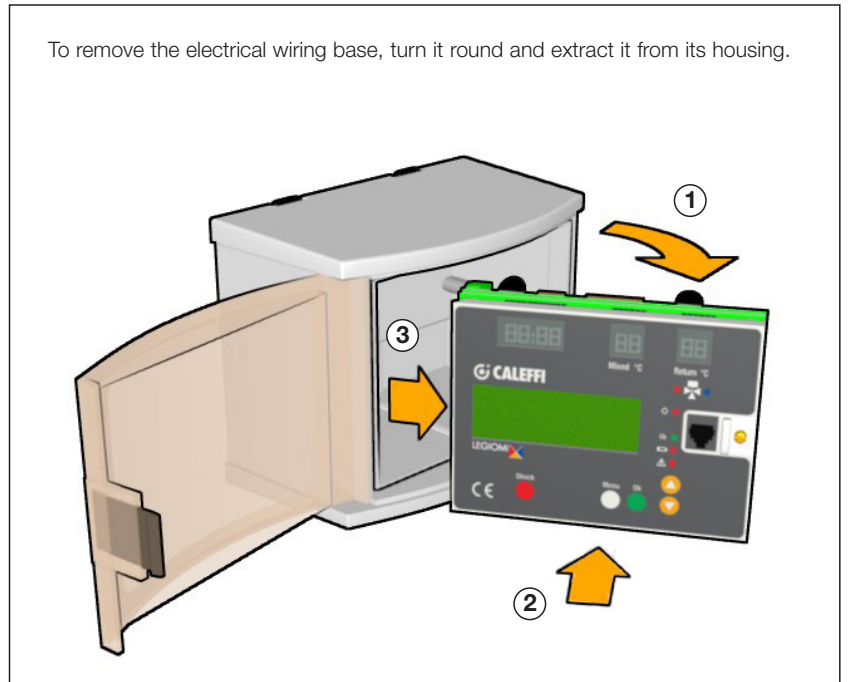

CAUTION: Risk of electric shock. The back panel and mixing valve contain live circuits. Cut off the electric supply before carrying out any work. Failure in following these instructions may result in injury of persons or damage to property.

CAUTION: Carrying out work with the electric supply connected may damage the electronics.

Back panel

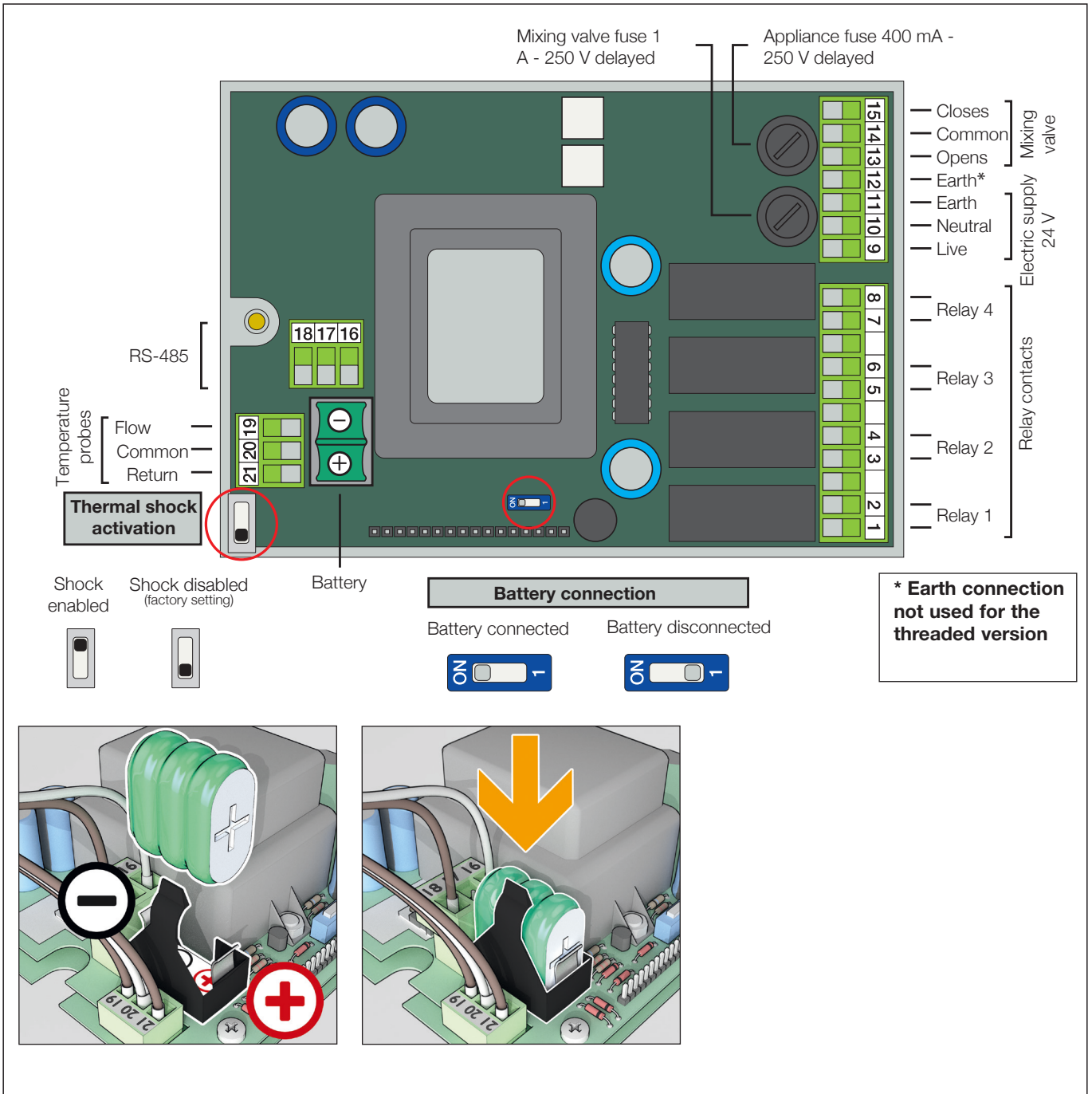

Connection of probes:
 The cable connecting the mixing valve and recirculation probes and the regulator must be installed in a dedicated raceway. If the connection cable shares the raceway with other power cables, an earthed shielded cable must be used.

Probe resistance table

°C	Ω	°C	Ω	°C	Ω	°C	Ω
-20	97060	20	12493	60	2488	100	680
-15	72940	25	10000	65	2083	105	592
-10	55319	30	8056	70	1752	110	517
-5	42324	35	6530	75	1480	115	450
0	32654	40	5327	80	1255	120	390
5	25396	45	4370	85	1070	125	340
10	19903	50	3603	90	915		
15	15714	55	2986	95	787		

If the polarity is reversed or if there is no power, the system will enter **BATTERY ALARM STATUS**; please refer to the "Alarms" section.

Location of cable seals

When making the electrical connections, keep to the following sequence for wiring the terminal strip and tightening the cable seals:

- 1 Power supply*
- 2 Mixing valve control*
- 3 Flow probe*
- 4 Recirculation probe*
- 5 RS485
- 6 Relay 3
- 7 Relay 1
- 8 Relay 4
- 9 Relay 2

*Already assembled in factory

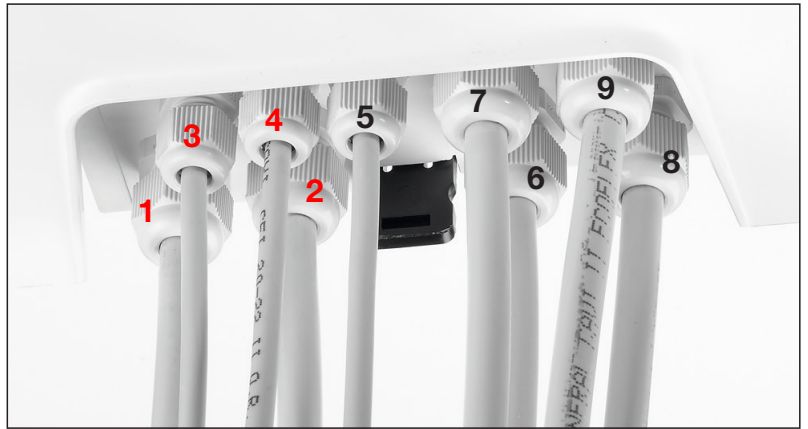

Enabling functions-Jumper and microswitch settings

Inside the appliance are a jumper and a microswitch: The first is used to enable/disable the Thermal Shock function.

The second is used to connect the internal battery (this is done at the time of installation).

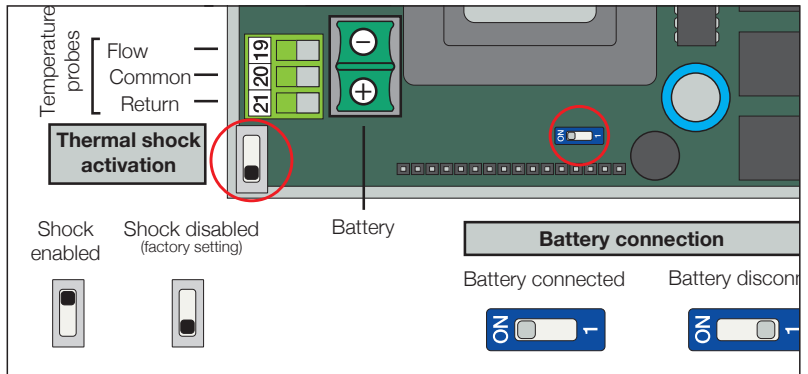

Important: If the battery is not activated the battery alarm will be displayed.



CAUTION!

The regulator is configured so that it executes a daily ball movement cycle, to ensure efficient ball operation and cleaning. This procedure is carried out after the disinfection program, if active, or in any case after 24 hours have elapsed if the disinfection is not active.

This function can be deactivated through the ANTI-CLOG item in the "SETTINGS" menu by entering the release code 5566 and confirming with ON-OFF.

Eliminating this function increases the risk of deposits forming on moving parts of the valve. If it is necessary to eliminate the disinfection function as well, it is advisable to proceed in the following order: first eliminate the ANTI-CLOG function, then eliminate the disinfection function.

Description of internal buttons and terminals

On the connection base are two buttons, which can be actuated by opening the front of the appliance: a reset button and a button for disabling the keypad (PIN).

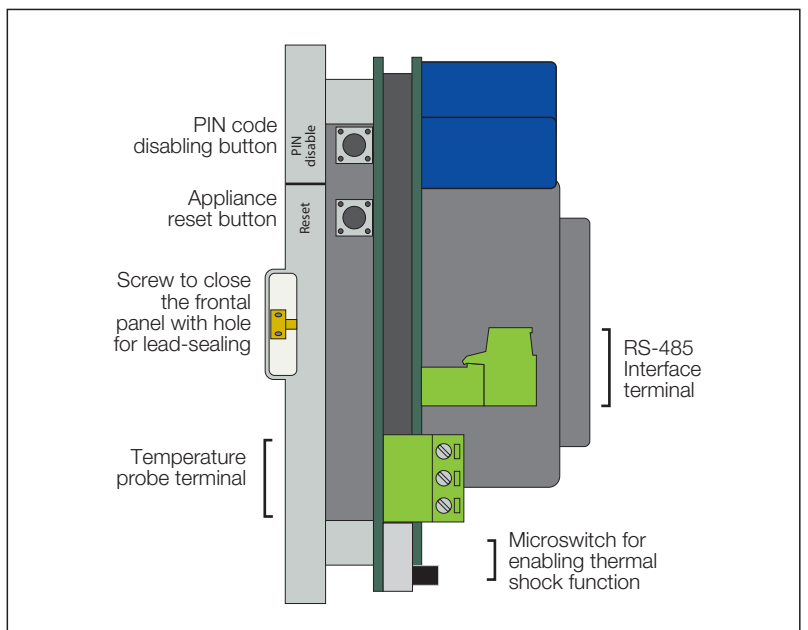

Dimensional characteristics to respect for circuit board wiring: connection cable cross-sections and lengths

Cable seal No.	Cable type	Unsheathing in mm including stripping (L)
1	3x1	130
2	6x0,75	150
3	2x0,75	210
4	2x0,75	210
5	3x0,75	210
6	2x1,5	160
7	2x1,5	160
8	2x1,5	180
9	2x1,5	160

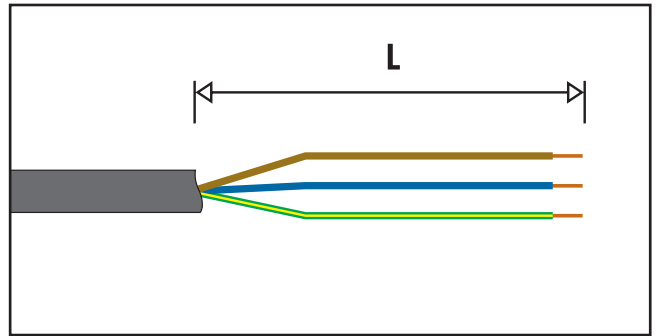

Connections layout: connections must not create thrust stresses on the circuit board

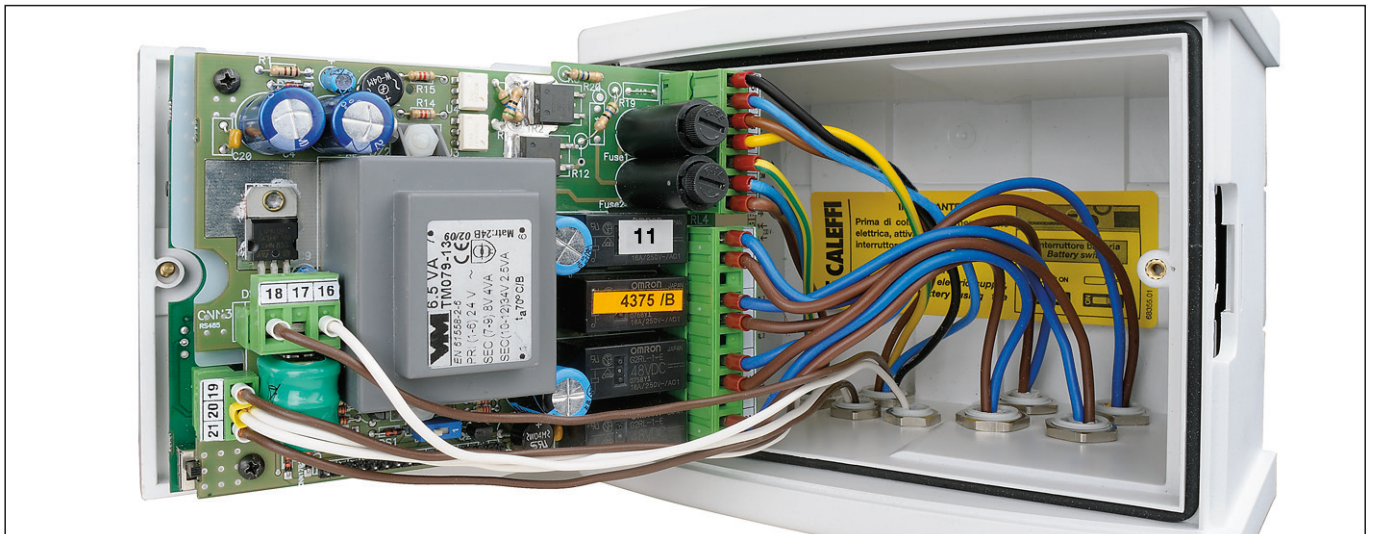

Front panel

We recommend (if not used) cutting the wires for the auxiliary microswitch and electrically insulating them before the wiring process (colours: white, green and red for the threaded version, white and red for the flanged version).

- 1 LCD display*
- 2 LED display: Time
- 3 LED display: Tmixed-flow temperature**
- 4 LED indicator
 - On
 - Status OK
 - Battery
 - Alarm
- 5 LED display: Treturn-return temperature**
- 6 Mixing valve open/close LED
- 7 Thermal shock button
- 8 Navigation buttons
 - Menu
 - OK
 - ▲ UP / ▼ DOWN
- 9 RS 485 front connection

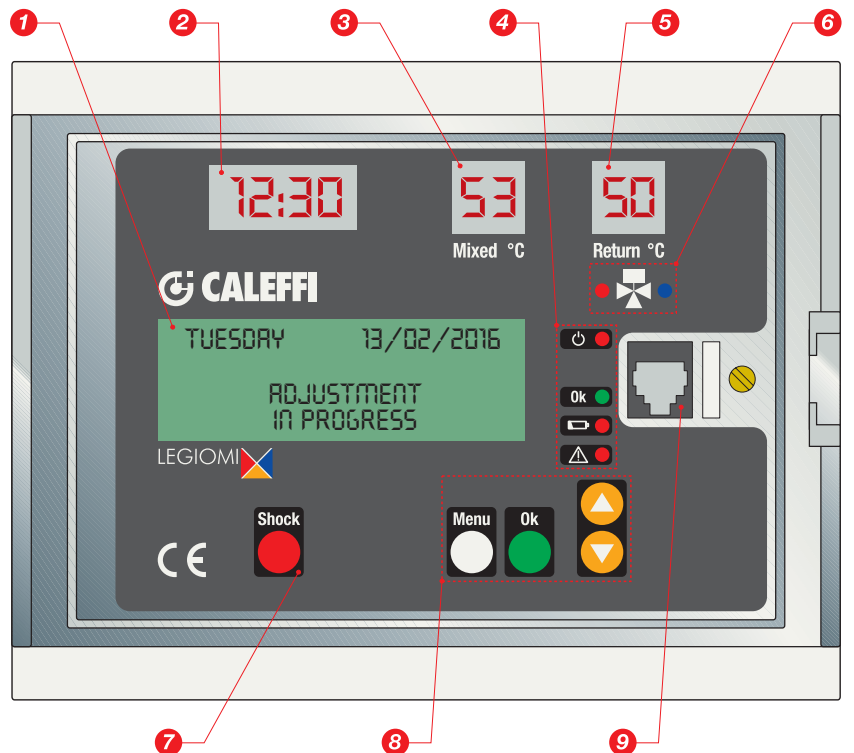







* LCD display. Values displayed in °F or °C. See settings (Default: °C).

** LED display. Can be on or off.

Indication description

Indications on LED display





On the front of the appliance are 3 LED displays, which show the clock time and temperature of the supply and return probes at all times. The flow and return temperature displays can be on or off, depending on the settings.

	Hour and minutes display (24 h system).
	Probe temperature display (in °C) Resolution 1°C
	Probe high "out of range" warning display. (blinking)
	Probe low "out of range" warning display. (blinking)
	Probe "open" warning display. (blinking)
	Probe "short circuit" warning display. (blinking)

If the recirculation sensor has been set as "not present" or faulty in program 0, the related display remains Off.

LED indicators

The following LED indicators are located on the front of the appliance:

	Mains power LED: red led: steadily ON when mains voltage is present.
	Mixing valve LED: - red LED : on when opening hot water - blue LED : on when opening cold water
	Appliance OK status LED: green LED: steadily ON when there are no faults or active alarms.
	Faulty battery LED: red LED: steadily on when there is a battery fault; otherwise it is Off.
	Generic Alarm LED: red LED: steadily ON when there is an alarm (probe fault, thermal shock in progress, reset); Flashes when on low power.

Indications on LCD display

On the front of the appliance is a green backlit alphanumeric display with four rows of 20 characters each, for setting parameters, scheduling operations, displaying error messages and machine status.

The buttons on the front panel ("MENU", "UP", "DOWN" and "OK") can be used to scroll through the menu items to configure the appliance, set the various parameters and view the temperature log.

Startup or Reset display

Quick display screen, showing appliance data and product reference code:



Operating status

When the appliance is in operation, the LCD display indicates the device status as shown in the following screens:

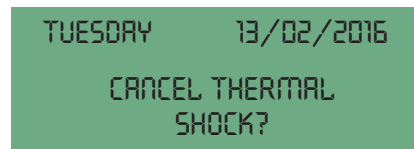
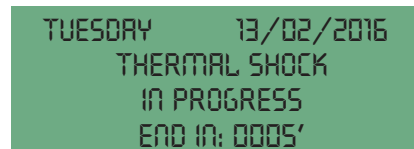
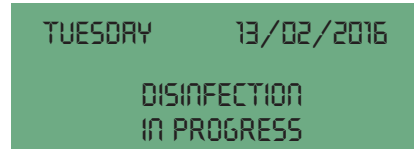

Operating status

Depending on the times and the programs that have been set, the appliance may be in one of the following operating modes:

- **Adjustment;**
- **Disinfection;**
- **Flushing;**
- **Thermal shock** (this function has priority over the previous ones);

In the event of a trouble due to the appliance or the system, the device manages and reports the alarm and, depending on the situation, may maintain operation or not. In this context, a distinction is made between the following statuses:

- Active with alarm
- Inactive with alarm

The appliance is equipped with a rechargeable battery that keeps the clock working in the event of electric supply failure.

In the event of a blackout, in order to ensure the longest possible operating time for the battery, the appliance assumes the status:

- Inactive on Low Power.

Regulation

In this mode the appliance continually checks the temperature detected by the flow probe and adjusts the mixing valve accordingly so that the flow temperature is maintained at the programmed set point.

Disinfection

In this mode the appliance carries out a disinfection phase, which consists of raising the water temperature to a pre-set value for a specific time duration, by operating the mixing valve as required.

Using the menu, it is possible to set the days of the week on which disinfection will be carried out.

At the end of disinfection, the statistical data relating to the disinfection that has just been concluded are logged.

This mode begins and ends automatically at a start time (TIMEON) and end time (TIMEOFF) that can be selected by the user.

CHECK ON DISINFECTION

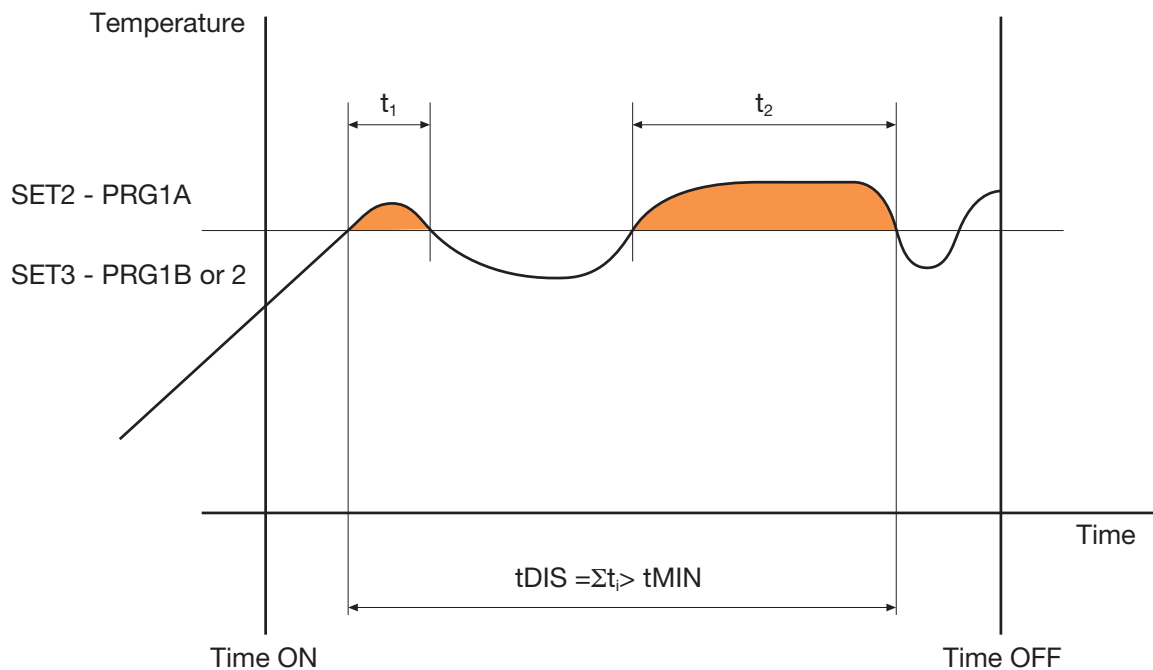

If, in the time span (Time OFF - Time ON), the actual disinfection time reached t_{DIS} is greater than the set t_{MIN} , the disinfection is concluded with a positive outcome. It automatically exits this status and returns to adjustment.

If it is not possible to reach a sufficient time t_{DIS} , the disinfection phase ends in any case at Time OFF.

Example:

Time ON: 2:00
 Time OFF: 3:00
 t_{MIN} : 30 min
 Program: 1A
 $T_{disinfection}$: 60°C

If, in the time span of 1 hour, the temperature remains over 60°C for at least 30 minutes, disinfection is successful and the regulator returns to adjustment mode. Otherwise, disinfection ends in any case at 3:00.

Programs

The operation of the regulator during disinfection can be set according to different programs, selected depending on the type of system and its management:

Program 0

This program features continual adjustment of the flow temperature with automatic disinfection in a time band that can be set. With this program the return probe is not used; if present, it is only used as a monitor.

During the disinfection phase, the flow probe temperature must remain above SET2 for a time tDIS at least equal to tMIN, if this occurs then disinfection has been successful.

As soon as there are the conditions to consider the disinfection successful, it is stopped. If the disinfection is not successful, there is no alarm signal.

Program 1A

This program features continual adjustment of the flow temperature with automatic disinfection in a time band that can be set. With this program the return probe is not used; if present, it is only used as a monitor.

During the disinfection phase, the flow probe temperature must remain above SET2 for a time tDIS at least equal to tMIN, if this occurs then disinfection has been successful.

As soon as there are the conditions to consider the disinfection successful, it is stopped.

If it is not possible to reach the disinfection temperature or it cannot be maintained for a sufficient period of time, the alarm for unsuccessful disinfection is generated. The alarm is recorded in the log.

The first time a button is pressed, the relay opens again.

The other alarm indications are cleared at the next successful disinfection.

Program 1B

This program can only be set if the return probe is set as present.

Identical to the previous program, the only difference being that the successful outcome of the disinfection phase is checked via the return probe in relation to SET3 instead of via the flow probe in relation to SET2.

As soon as there are the conditions to consider the disinfection successful, it is stopped.

If it is not possible to reach the disinfection temperature or it cannot be maintained for a sufficient period of time, the alarm for unsuccessful disinfection is generated.

The alarm is recorded in the log.

The first time a button is pressed, the relay opens again.

The other alarm indications are cleared at the next successful disinfection.

Program 2 (factory settings - default)

This program can only be set if the return probe is set as present.

Identical to the previous program, the only difference being that, if after a wait time tWAIT since the start of disinfection, the return temperature does not reach SET3, the flow temperature SET2 is increased by a value equal to (SET3 – TR reached), considering that SET2 cannot however exceed the limit SETMAX.

This correction procedure (increasing only) of the disinfection SET is iterative: if necessary, it is repeated in the time span defined by TimeON and TimeOFF at each time interval equal to tWAIT.

As soon as there are the conditions to consider the disinfection successful, it is stopped.

If it is not possible to reach the disinfection temperature or it cannot be maintained for a sufficient period of time, the alarm for unsuccessful disinfection is generated.

The alarm is recorded in the log.

The first time a button is pressed, the relay opens again.

The other alarm indications are cleared at the next successful disinfection.

Interrupting disinfection

Disinfection can be interrupted while it is still in progress. On the working screen (which shows the message “disinfection in progress”), press the OK button once. The display shows the message “Cancel disinfection?”; at this point, the OK button can be pressed to stop the disinfection and return to the adjustment function (without going through the flush phase).

If the OK button is not pressed, after a timeout of about 3 seconds, the display goes back to displaying the message “disinfection in progress”.

Table of thermal disinfection programs

Program	Use of return probe	Return probe shown on LED display	Adjustment temperature	Disinfection temperature	Alarm if disinfection unsuccessful	Recording in log if disinfection unsuccessful
0	NO	As monitor only	SET 1	SET 2	NO	NO
1A	NO	As monitor only	SET 1	SET 2	YES	YES
1B	YES	YES	SET 1	SET 3	YES	YES
2	YES	YES	SET 1	SET 3 +modify SET 2	YES	YES

Flushing

The appliance goes into this mode automatically after the disinfection phase. It can be used, for example, to bring the water temperature back to the SET1 value, or periodically to clear possible residues from the storage.

This phase is ended after a time selected with the tFLUX parameter.

When the flushing time has ended, relay 1 and relay 4 are deactivated and the appliance returns to the "adjustment" function.

Thermal shock

In this mode, the appliance regulates the supply temperature at the thermal shock value selected with the SETSH parameter, for the period selected with the tSH parameter.

This function is associated with activation of alarm AL4, and illumination of the alarm LED.

Thermal shock can be started by pressing the special button on the front panel (pressing and holding for at least 5 sec.) while the working screen is displayed, or can be programmed using the related menu item, to run after a certain delay (countdown in minutes) or when a remote command is received.

After activating the procedure, it is anyhow possible to stop it by pressing the shock button and confirming with the "OK" button (guided procedure on the display), or by remote control.

As this is a potentially dangerous function, a jumper is provided on the printed circuit board to enable it. If the jumper is closed, the Shock function can be used; if it is open, it is not available (see Back Panel section).

At the end of the Thermal Shock phase, the appliance reverts to its "adjustment" function.

Low Power

This mode is activated if there is no electric supply.

The appliance continues running the internal date clock; however, in this state there is no power for switching the relays, so the regulator does not perform the adjustment or disinfection functions.

Probe temperatures cannot be acquired, and no communications are possible.

The mixing valve is left in the state it was in at the time of the power failure.

LCD is Off.

LED displays are Off.

All LEDs are Off, except the "alarm" LED, which is flashing.

When mains power is restored, the blackout is registered in the log (alarm AL5), and the appliance resumes the programmed functions, unless the power failure lasted for a time long enough for the battery to become fully discharged. In this case the appliance will be reset when the mains power is restored.

In the event of a reset or extended power failure, the factory settings are restored. If modifying the factory settings, make a copy of the new settings.

Reset

On the back panel there is a reset button, in case it is necessary to restore the initial settings.

For more information, see the description of alarm AL6 in the section on alarms management.

After a reset or when switched on, if the date and time have not been set, the controller operates according to factory setting SET1.

(The DST, tMOTOR, tPLAY and ProgDay settings will not be changed)

Actuation relays

The electric supply board and terminals show the relay contacts used to manage auxiliary equipment and to report alarms.

- Relay 1: circulation pump (active during disinfection).
- Relay 2: generic alarm (probe fault, battery fault, blackout or clock failure). This relay is connected through the NC contact.
- Relay 3: second thermostat.
- Relay 4: flushing valves.

Summary of actuation relay statuses

Working status	Adjustment	Disinfection	Flushing	Thermal shock
Relay	Contact status	Contact status	Contact status	Contact status
Relay 1: recirculation pump	Open	Closed	Closed	Closed
Relay 2: generic alarm	Open	Open	Open	Closed
Relay 3: second thermostat	Open	Closed	Open	Closed
Relay 4: flushing valves	Open	Open	Closed	Open

Operating parameters. Summary of parameters. Setting ranges and factory (default) configuration

No.	Parameter	Description	Setting range	Factory (default) configuration
1	Language	The language in which text will be shown on the LCD display	I-E-F-D-ES-P-NL-SL-HR-SR-RO	ENGLISH
2	Date/Time	Used to manage the disinfection phase and log entries	DD/MM/YY	01/01/2017
3	DST	Daylight saving time setting	USA / CUS / NO / EUR	EUR
4	D appliance "BUS ID"	Number that identifies the product among those connected to the bus	from 0 to 255	001
5	SET_MAX	Sets the maximum temperature limit: for protecting the system. None of the SET values can exceed SET MAX	from +50°C to 90°C 122 - 194°F	65°C 149°F
6	SET1	Setpoint for Ta (flow temperature) during the adjustment phase	from +20°C to 85°C 68 - 185°F	45°C 113°F
7	SET2	Setpoint for Ta (flow temperature) during the disinfection phase	from +40°C to 85°C 104 - 185°F	60°C 140°F
8	SET3	Setpoint for Tr (return temperature) during the disinfection phase In the case of programs 1B or 2 if a value lower than 50°C is set, the message "disinfection not completed" will be displayed	from +40°C to 85°C 104 - 185°F	57°C 140°F
9	Return probe present (Ric probe)	The return probe is the analogue type (NTC)	NO=absent YES=present	YES
10	PGRM program	To modify the working parameters for managing the disinfection phase	PRGM 0 =0 PRGM 1A=1 PRGM 1B=2 PRGM 2 =3	2
11	ProgDay	Disinfection is carried out only on the selected days. Programming is by the week	1 2 3 4 5 6 7	1 2 3 4 5 6 7
12	TIME ON	Start time for the programmed disinfection	HHMM	02:00
13	TIME OFF	End time for the programmed disinfection	HHMM	03:00
14	tWAIT	Represents the time considered necessary for the system to bring the return water to a temperature above SET3	1 to 255 min	002 min
15	tMIN	The minimum time for which the temperature of the flow probe (or return probe in the case of programs 1B or 2) must remain above the setpoint selected for disinfection so that it will be completed successfully.	from 0 to 254 min (max 4,14 h)	030 min
16	tFLUX	Duration of the flushing phase that will start automatically when a disinfection phase is completed	from 0 to 2550 s in steps of 10 s	0000 s
17	tPLAY	Delay due to gap in mechanical components during actuator movement, until the internal obturator starts to move in the opposite direction	from 1 to 255 s in steps of 1 s	0005 s
18	tMOTOR	Time required for the actuator to change the valve from fully closed to the fully open position. Recommended default value. Contact Caleffi. (Not the physical operating time).	from 8 to 320 s in steps of 2 s	0100 s
19	ANTI-CLOG	Ball rotation cycle for cleaning deposits. To deactivate it, enter code 5566 and confirm with ON-OFF.	ON / OFF	ON
20	SETSH	Setpoint for Ta (flow temperature) during shock phase	from +30°C to 85°C 86 - 185°F	60°C 140°F
21	tSH	Duration of thermal shock phase to be started manually by the user	1 to 4320 min	005 min
22	Countdown	Countdown before activating thermal shock	0 to 999 min	0001 min
23	Activate countdown	Enables activation of countdown before thermal shock	NO= not active YES=active	NO
24	Cels - Fahr.	Temperature measurement unit	°F / °C	°C

Log

The “log” is a FIFO list (First In - First Out, loop buffer) that is continually updated and records parameters relating to adjustment and disinfection phases that occurred during the day.

Data are stored for the last 40 days, after which the data for the first day are overwritten, and so on.

The hourly average flow and return temperatures are saved to Eeprom every hour, whereas alarms are saved at the time they occur.

At any time it is possible to view the average hourly values of the current day (obviously the ones already recorded).

The disinfection data are saved when disinfection ends.

It is possible to view the log on the display (via the specific menu item) or remotely via the RS485 serial interface.

The parameters saved in the log are:

- Date (day, month, year).

- Selected program. This is saved when disinfection starts.

- tDIS: actual disinfection time (in steps of minutes).

When the set program is 0 or 1A, this parameter is the time when the temperature of the flow probe was above SET2.

When the set program is 1B or 2, this parameter is the time when the return probe was above SET3.

This is helpful when it is less than tMIN, to understand how much greater the span of TIME ON: TIME OFF should be to complete the disinfection.

- TRMAX: Maximum temperature of the return probe during disinfection (if a disinfection was completed that day).

- TRMIN: Minimum temperature of the return probe during disinfection (if a disinfection was completed that day). It is calculated from the time when the return probe measured a value greater than SET3, beginning from the time when the disinfection starts being effective.

- Alarms AL1, AL2, AL3, AL4, AL5, AL6, AL7, if these had been activated during the day concerned.

- 24 hourly average flow temperature values.

- 24 hourly average return temperature values.

- Marker indicating whether the previous data are reliable. Used in the event of a reset, adjustment of clock time, change of date and any other event that might have made the stored data unreliable.

If no disinfection was completed on that day, then the related fields will contain a default value.

If there have been any faults in one or both probes, the hourly average data will be represented by dashes.

If there are any “gaps” or unavailable data due to a change of date, time, etc., the cells will contain a default value and will be represented on the display by dashes.

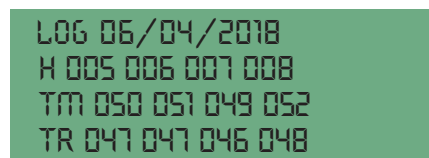
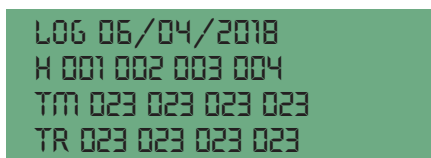

Deleting the log

The log can be **completely erased from the non-volatile memory**, by following the procedure below:

Select the “temperat. log” menu item and press the OK button.

The display shows the data from the first log record available.

Now press and hold the Shock button for at least 1 s.

The display shows a blank screen, which is then gradually filled, indicating that the delete operation is in progress; the LCD display then shows the menu selection screen (higher level), and the log has been completely erased.

If you now go into the log submenu, the only record available will be the one for the present day; note that the temperatures for all hours previous to the present one have also been deleted.

IMPORTANT: once initiated, the delete operation cannot be cancelled.

Battery

The appliance has an integrated rechargeable battery (three 150 mAh cells), used to keep the internal clock running and maintain the selected settings even if there is a mains power failure.

While in operation, the level of charge in the battery is checked periodically (about every 24 h), and the recharge function is activated if necessary.

When the battery recharge function is active, the “Btr” icon appears in the working window (adjustment mode). 



Battery charging indication



Battery fault indication

If the parameter readings are not within the specified range, it means the battery is damaged and must be replaced.

If a battery fault is detected, the corresponding alarm appears (see the Alarms paragraph):

In principle, a battery fault should not affect any of the appliance functions, unless there is also a power supply failure.

Access PIN code

Menu navigation can be prevented by enabling the keypad lock function. The keypad is then unlocked by entering a PIN code. If the lock function is enabled, the keypad is locked automatically after a timeout of 10 minutes starting from the last button press.

When the keypad lock function is active, a padlock symbol appears on the working screen (see right): 

Also, if the lock function is active and a button is pressed while the working screen is displayed, the PIN code input screen appears: The code is entered by selecting the first digit using the "UP" and "DOWN" buttons, then confirming by pressing OK. The second digit is entered in the same way, and so on.

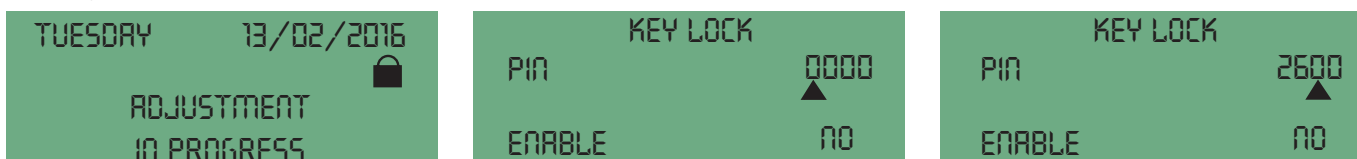

When the last digit is confirmed, if the code is correct, the user can access the menus; if the code is incorrect, the PIN entry screen appears again. If the timeout elapses, the display shows the working screen again.

If the PIN code is lost or misplaced, the lock function can be overridden (the PIN code is forced to 0000) by pressing a button on the back of the panel (for 5"), or by sending a special command through the RS485 interface.

Entering programs and settings

Appliance operation is based on an internal clock with calendar and automatic time adjustment.

By navigating through the appropriate menu items and using the buttons on the front panel ("MENU", "UP" ▲, "DOWN" ▼ and "OK"), the user can configure the appliance, set the various parameters, and display the temperature log.

Functions of the configuration buttons

Description	Display	Button function	Effect
Menu item - arrows beside the row	▶ ◀	▲ UP ▼ DOWN	Moves the cursor to another row
		+ OK	Opens the related submenu
		Menu	Go back to previous level
Other rows displayed	▲ ▼	▲ UP ▼ DOWN	View other rows in the menu - arrows at the edge of the screen
Parameter selection	▶ ☹ ◀	▲ UP ▼ DOWN	Increases or decreases the parameter value - flashing cursor
		+OK	Confirms the setting - cursor disappears and value is applied
		Menu	Return to previous level without making changes

Whatever status the appliance is in (except Low Power), it is always possible to navigate around the various menus to read the various settings and view the stored log data.

However, for safety reasons, **the settings data can be modified only when the appliance is in "Adjustment" mode.**

In particular, parameters cannot be modified while the appliance is in "disinfection", "flushing" or "thermal shock" mode, and when the appliance is in the "inactive with alarm" status.

The various options are made available, depending on whether the return probe has been enabled.

To set programs 1B or 2, the return probe must be set as Present.

To be able to remove the return probe (i.e. set it as Present or Absent), program 0 or 1A must be set first.

Pre-equipped for remote control

The regulator can also be controlled from a remote computer, too, since it is equipped with an RS485 serial output connection, which can be accessed by hard-wired terminals and through the connector on the front panel.

Since the interface is the multipoint bus type it is necessary for each appliance connected on the bus to be identified by an appropriate address in order to avoid identification conflicts.

For a detailed description of the operations and controls that are possible from a remote location using this interface, please refer to the relevant documentation.

Menu structure table

Level 1	Level 2	Level 3	Button functions
LANGUAGE SEL	LANGUAGE SEL		
	I - E - F - D - ES - P - NL -		▲ UP ▼ DOWN + OK
	SL - HR - SR - RO		
 When switching on, you will need to confirm the language. If the language is not selected within one minute, the menu will move on to the date and time setting procedure. The language can always be changed via the "settings" menu.			
DATE/TIME	DATE/TIME		
	DATE 01-01-2017	Set: day/month/year	▲ UP ▼ DOWN + OK
	TIME 00:00	Set: hours	
	CHANGE TIME EUR	USA - CUS - NO - EUR	▲ UP ▼ DOWN + OK
SETTING	SETTING		
	Bus ID 001	from 0 to 255	▲ UP ▼ DOWN + OK
	SET MAX 065°C	from 50°C to 90°C	▲ UP ▼ DOWN + OK
	SET1 045°C	from 20°C to 85°C	▲ UP ▼ DOWN + OK
	SET2 060°C	from 40°C to 85°C	▲ UP ▼ DOWN + OK
	SET3 057°C	from 40°C to 85°C	▲ UP ▼ DOWN + OK
	Ric probe YES	NO - YES	▲ UP ▼ DOWN + OK
	PRGM 2	0 - 1A - 1B - 2	▲ UP ▼ DOWN + OK
	Prog.day -----	Select day	OK
	Time ON 02:00	Set time	▲ UP ▼ DOWN + OK
	Time OFF 03:00	Set time	▲ UP ▼ DOWN + OK
	tWAIT 002'	from 1 to 255 minutes	▲ UP ▼ DOWN + OK
	tMIN 030'	from 0 to 254 minutes	▲ UP ▼ DOWN + OK
	tFLUX 0000"	from 0 to 2550 seconds	▲ UP ▼ DOWN + OK
	tPLAY 005"	from 1 to 255 seconds	▲ UP ▼ DOWN + OK
	tMOTOR 100"	from 8 to 320 seconds	▲ UP ▼ DOWN + OK
	ANTICLOG ON	ON - OFF (see instr. page 8)	
THERMAL SHOCK	THERMAL SHOCK		
	SETSH 060°C	from 30°C to 85°C	▲ UP ▼ DOWN + OK
	tSH 0005'	from 1 to 4320 minutes	▲ UP ▼ DOWN + OK
	COUNTDOWN 001'	from 0 to 999 minutes	▲ UP ▼ DOWN + OK
	ACTIVATE countdown NO	NO - YES	▲ UP ▼ DOWN + OK
TEMPERAT. LOG	VIEW TEMPERATURE LOG		
	DD/MM/YY UP-DOWN	LOG DD/MM/YY (Example)	▲ UP ▼ DOWN + OK
		tDIS 060'	
		PRGM 2	
		TR MAX 58°C	
		TR MIN 48°C	
		ALARM	1234567
		h 01 02 03 024	
		TA 40 43 35 45	
		TR 38 40 33 43	
KEYPAD LOCK	KEYPAD LOCK		
	PIN 0000	Select code	▲ UP ▼ DOWN + OK
	ENABLE NO	NO - YES	▲ UP ▼ DOWN + OK

Hydraulic installation

Before installing the Caleffi mixing valve, the pipes must be flushed to prevent impurities in the water from affecting performance.

We recommend always installing strainers of sufficient capacity at the inlet from the water main.



If the system is washed with chemicals, leave the relevant flow temperature probe housing end plug on.

For subsequent washing procedures, disconnect the temperature probe and fit the relevant plug.

Only connect the probe **after** washing has been completed.

Caleffi electronic mixing valves must be installed as shown on the installation diagrams in this manual, and taking account of applicable current regulations.

Caleffi electronic mixing valves may be installed either vertically or horizontally, but the actuator must not be upside down.

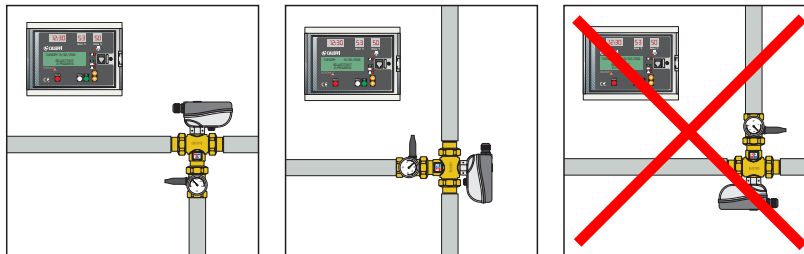

The following are indicated on the body of the mixing valve:

-Hot water inlet with red arrow

-Cold water inlet with blue arrow

Check valves

In systems with mixing valves, check valves should be fitted to prevent undesired backflows, as shown in the diagrams.

Commissioning

Due to the special purposes for which the electronic mixing valve will be used, it must be commissioned in accordance with current regulations and by qualified personnel using suitable measuring instruments. Check that the hot and cold water supply pressures are within the operating limits of the mixing valve. Check the temperature of the hot water from the storage, $T \geq 60^{\circ}\text{C}$.

In the installation log book, record all the parameter settings made and the measurements taken.

Thermal disinfection

The temperatures and corresponding times for disinfection of the system must be selected according to the type of installation and its intended use. To meet the requirements of the most recent world legislation on this matter, the following criteria can generally be followed:

T = 70°C for 10 minutes

T = 65°C for 15 minutes

T = 60°C for 30 minutes

Thermal disinfection is generally carried out at times when there is less demand on the system, for example at night; this is to minimize the risk of users being scalded. It is recommended to perform thermal disinfection every day and at least once a week.

To ensure that thermal disinfection is actually performed at the desired temperature and for the specified time, please refer to the sections on regulator functions and management of the special programs.

Guide table for thermal disinfection programs

Type of check	Progr.	Use of return probe	Adjustment temperature	Disinfection temperature
Adjustment and simple disinfection without check	0	NO	Flow: 50–55°C	Flow: 60°C
Adjustment and disinfection check on the flow temperature	1A	NO	Flow: 50–55°C	Flow: 60°C
Adjustment and disinfection check on temperature of return flow to heating system	1B	YES	Flow: 50–55°C	Return: 57°C
Adjustment and disinfection check with change of flow temperature according to return temperature	0 - 1A 1B - 2	Reading only	55°C – 24 h	See T adjustment
24 h continuous disinfection	2	YES	Flow: 50–55°C	Return: 55°C with adjustment of flow up to maximum value

Relay contact for recirculation pump and second storage thermostat

Below is the wiring diagram of relay 1 with a clock for managing the recirculation pump times.

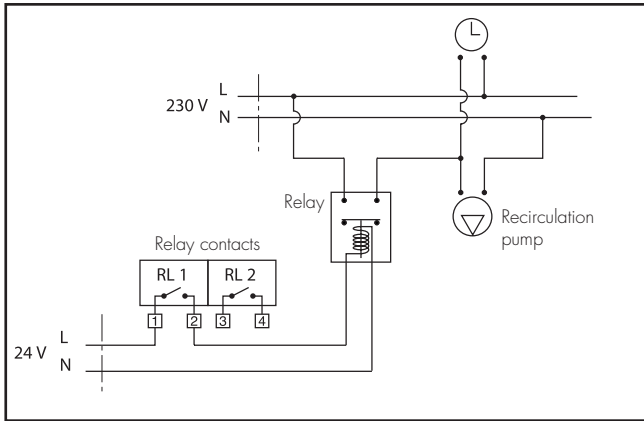

Below is the wiring diagram of relay 3 for connection to the second thermostat on the hot water storage.

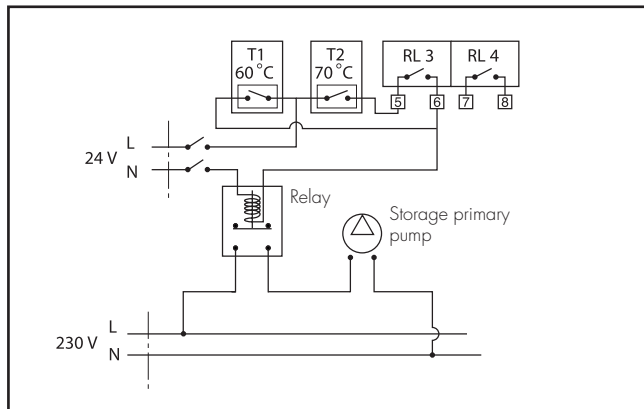

Maintenance

Tests are carried out while in service, to regularly monitor the performance of the mixing valve, since any loss of performance may indicate the need for maintenance of the valve and/or the system. During these tests, if the temperature of the mixed water is found to have changed significantly compared with previous tests, we recommend referring to the sections on installation and commissioning and carrying out maintenance.

We recommend carrying out the following checks periodically to ensure that the valve continues to deliver optimum levels of performance. At least every 12 months, or more frequently if required.

- 1) Check and clean the strainers in the system.
- 2) Make sure that any check valves installed at the inlet of the Caleffi valve are functioning correctly, and there are no leaks caused by dirt.
- 3) The internal components of the valve can be descaled by immersing them in a suitable descaling liquid.

This operation is essential in the case of systems that are used seasonally, for example in hotels and similar establishments.

- 4) Once the maintainable components have been checked, we recommend following the commissioning procedure again. On the system log book, record all operations carried out.

Buffer battery replacement procedure

If necessary, it is possible to replace the buffer battery removing the low battery from its seat and inserting the new one, observing the correct polarity, as shown in the figure:

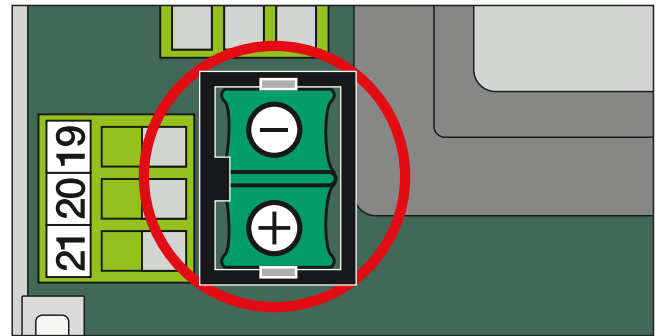

Functional faults

A special set of alarms has been provided to help manage possible faults that can occur in the regulator and the system. Please refer to the "Alarms Management" section below.

Manual opening procedure for flanged versions

To perform manual opening, in the case of a fault or power failure, proceed as follows:

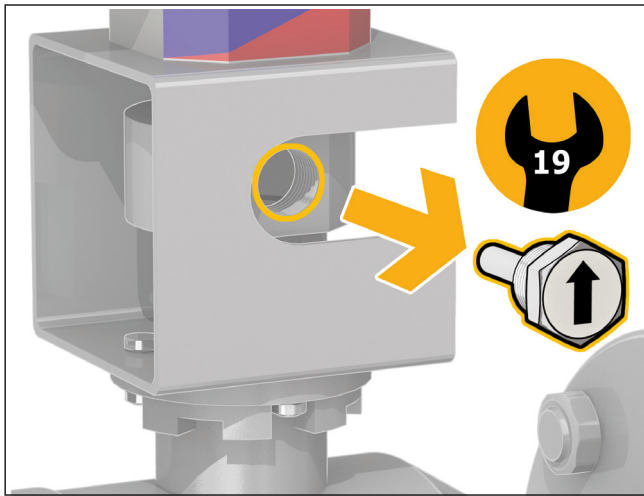

1) Unscrew the threaded locking pin using a 19 mm wrench.

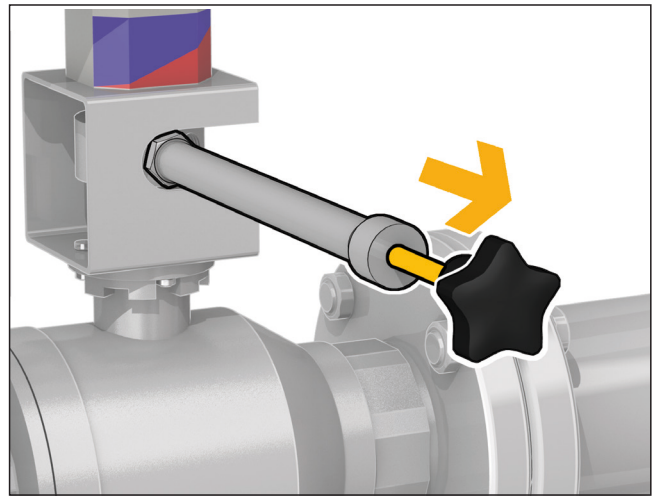

4) Pull the knob outwards.

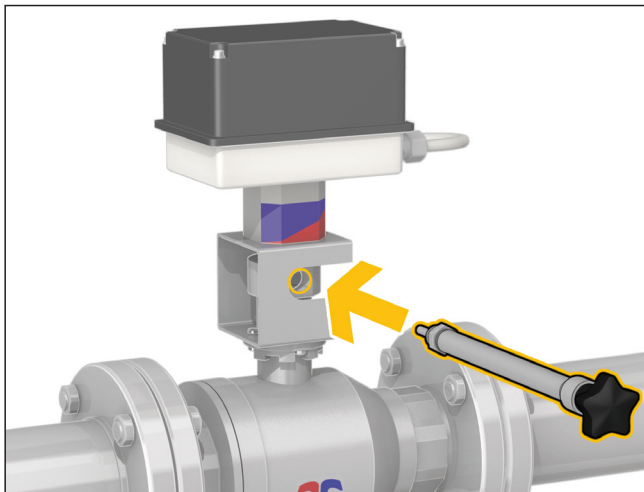

2) Screw the specific lever (supplied) into the locking pin hole.

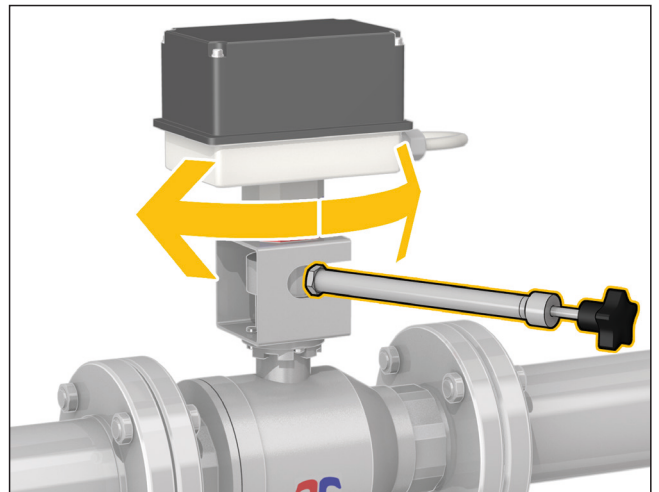

5) Rotate the valve to the desired position.
During these operations take precautions to avoid the danger of scalding to users.

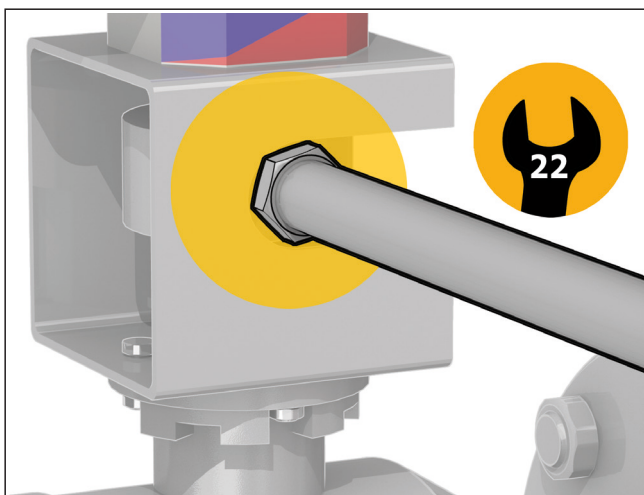

3) Lock the lever in position using the specific locknut with a 22 mm fixed wrench.

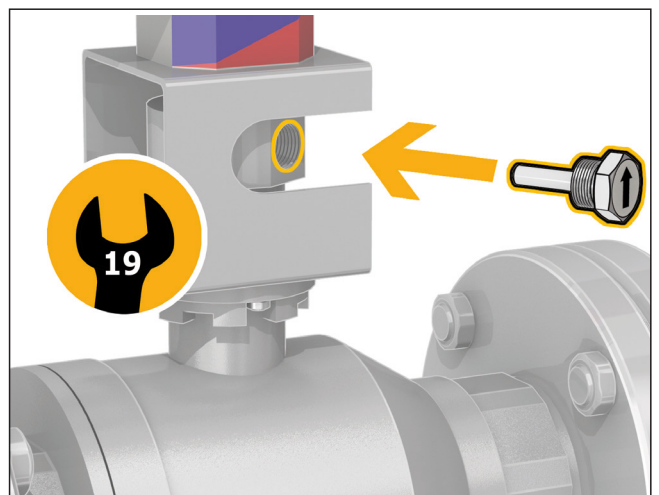

6) When the operations are complete, realign so that the knob engages and screw the locking pin back into its threaded hole.

Alarm management

To make it easier to resolve any functional faults that occur after installation and commissioning, the regulator is configured so that faults are indicated by special alarms and the appropriate action is taken.

In this case, the cause of the alarm is shown on the LCD display:

If the alarm does not inhibit all the functions, the alarm screen will alternate with the appliance status screen.

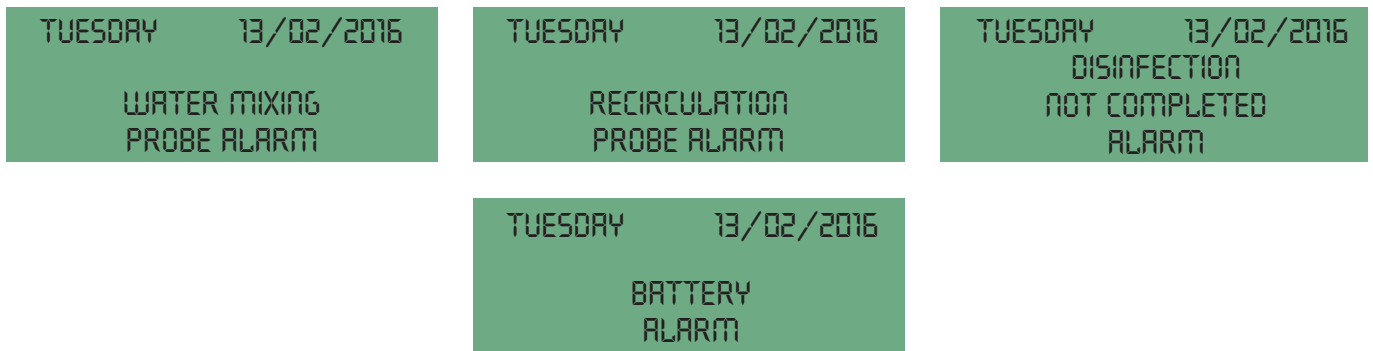

Alarm description table

Alarm indicator	Description
AL1	Flow probe faulty
AL2	Return probe faulty
AL3	Disinfection failed
AL4	Thermal Shock in progress
AL5	Mains power failure
AL6	Appliance reset
AL7	Battery faulty

Depending on the type of alarm, certain actions are undertaken, relay statuses modified and information shown on the LED displays, LCD display and LEDs on the front panel.

The following table gives a summary of the various operating statuses that follow an alarm.

Operability table after an alarm

Type of alarm	Program	Indication by alarm LED	Indication by LED display	Display on LCD	Recording in log
AL1: flow sensor fault	0 1A 1B 2	"Generic alarm" LED comes on and "Status OK" LED goes off.	Alarm shown on LED display. ("HI", "LO", "SH", "OP" depending on case).	"Flow probe fault" alarm displayed on LCD.	YES (AL1) Stored in the day log.
Return probe fault	0 1A	The alarm LED remains off and the "Status OK" LED remains on.	Remains off if program 0, and "HI", "LO", "SH", "OP" displayed (depending on case) if program is 1A.	NO	Fault is recorded in day log.
AL2: return probe fault.	1B 2	"Generic alarm" LED comes on and "Status OK" LED goes off.	Alarm shown on LED display. ("HI", "LO", "SH", "OP" depending on case).	"Return probe fault" alarm on LCD (screen alternates with working screen).	YES (AL2) Stored in the day log.
Disinfection not completed	0	The alarm LED remains off and the "Status OK" LED remains on.	NO	NO	NO
AL3: disinfection not completed	1A 1B 2	"Generic alarm" LED comes on and "Status OK" LED goes off.	NO	"Disinfection not completed" alarm on LCD (screen alternates with the working screen).	YES (AL3) Stored in the day log.
AL4: Thermal shock in progress	0 1A 1B 2	"Generic alarm" comes on (but, if no other faults, the "Status OK" LED also remains on).	NO	"Thermal shock in progress" alarm on the LCD display.	YES (AL4) Stored in the day log.
AL5: blackout (no mains power)	0 1A 1B 2	The indicator LEDs remain Off. Only the generic alarm LED flashes.	Temperature indicators and clock remain off. Temperatures are not acquired.	LCD remains off.	Recording of log data is suspended. YES (AL5) When power is restored it is stored in the log.
AL6: appliance reset	0 1A 1B 2	Generic alarm LED comes on and "OK status" LED off.	Time 00:00 flashes on the display Time on LCD.	Data input screen opens, and when this has been set, 01/01/2005 appears in the Data field of the LCD display.	YES (AL6) Stored in the day log.
AL7: battery damaged	0 1A 1B 2	"OK status" LED goes off. "BTR FAIL" LED comes on. (The generic alarm LED is not on).	NO	"Battery damaged" appears on LCD display (alternating with the working screen).	YES (AL7) Stored in the day log.

Relay status	Operating status
Relay 2 closed (if no alarms, the relay is normally open).	In safe mode. Mixing valve closes, i.e. only cold water enters. Adjustment or disinfection or thermal shock is cancelled. All alarm indications are cleared when the cause of the alarm has been removed.
Relay 2 open. The alarm relay does not change status.	All functions are ensured. The return probe, if present, is used as a monitor only, since it does not generate an alarm if faulty.
Relay 2 closed (if no alarms, the relay is normally open).	No disinfection, but adjustment continues and thermal shock is possible. When the first button is pressed, the relay re-opens; indication remains on the display. In all cases, all alarm indications are cleared when the cause of the alarm has been removed.
Relay 2 open. The alarm relay does not change status.	Disinfection failure does not generate any alarms.
Relay 2 closed (if no alarms, the relay is normally open).	When the first button is pressed, the relay re-opens; indication remains on the display. In all cases, all alarm indications are cleared when the cause of the alarm has been removed, in this case when the next disinfection is successfully completed. Note: if program 0 is set, any unresolved alarm indication due to incomplete disinfection is cleared.
Relay 2 closed (if no alarms, the relay is normally open).	Alarms generated. The thermal shock function is potentially dangerous for users of the system. When the first button is pressed, the relay re-opens; indication remains on the display. In all cases, all alarm indications are cleared when the cause of the alarm has been removed, in in this case when the shock function has ended and the appliance begins adjustment again.
Relay 2 closed (if no alarms, the relay is normally open).	If there is a mains power failure, the back-up battery keeps the appliance's internal clock running. In this situation, all actuations are inhibited (the relays cannot be operated), and therefore so are all the adjustment, disinfection and thermal shock programs. In this status, the appliance goes into Low Power mode in order to ensure maximum autonomy. The RS485 interface is not available. When the mains power is restored, the blackout is recorded in the log (AL5), and the appliance resumes operation based on the programmed functions, without any alarm indication. However, if the mains power failure lasts long enough for the battery to become discharged, there is a general reset when power is restored.
	The printed circuit board has a button for hardware reset of the appliance. This button cannot be operated from the front panel, but only by opening the door of the appliance and accessing the printed circuit board. If the appliance is reset accidentally, or intentionally by pressing the special hidden button, or by interference (lightning, etc.), the correct time and date settings are lost. Settings made by the user are also lost, and the factory values are reloaded for all parameters and settings. Therefore, until the correct date and time are re-entered: Appliance remains active in adjustment mode. Disinfection is inhibited. Thermal shock program is inhibited (but thermal shock can still be forced manually or remotely). When the current date and time have been set (manually or remotely), the device comes out of the alarm condition and resumes normal operation. All alarm indications are cleared.
Relay 2 open. The alarm relay does not change status.	While in operation, the level of charge in the battery is checked periodically (about every 24 h), and the recharge function is activated if necessary. If the parameter readings are not within the specified range, it means the battery is damaged and must be replaced. However, the appliance continues performing the specified programs, since a battery fault does not affect any of the appliance functions (unless there is a blackout). NOTE: when changing the battery, please refer to the procedure described on page 19.

Application diagrams

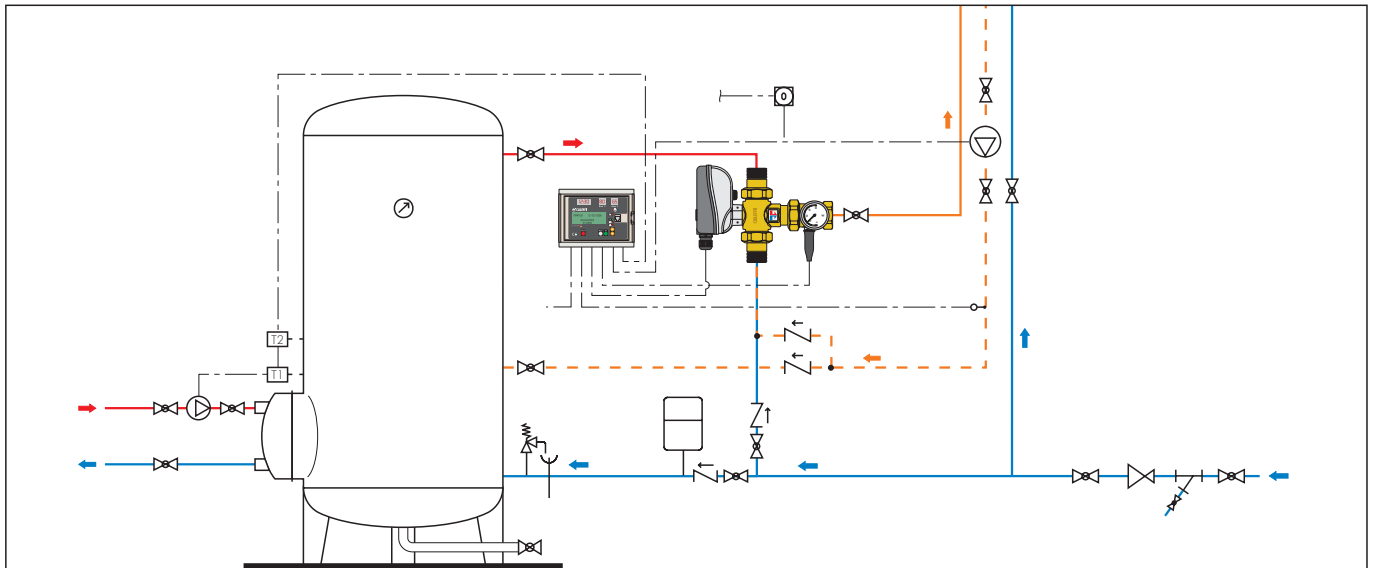
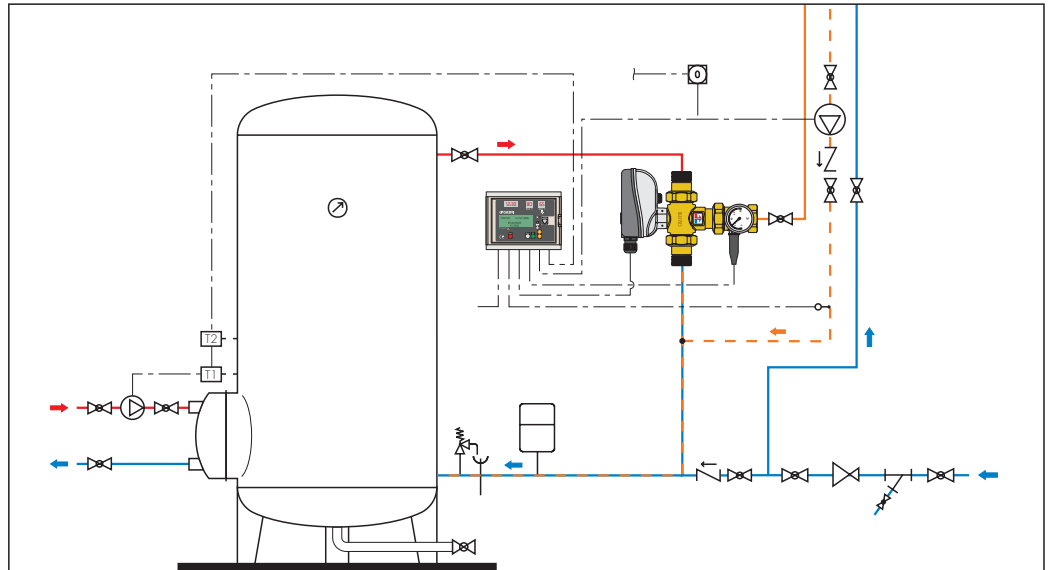
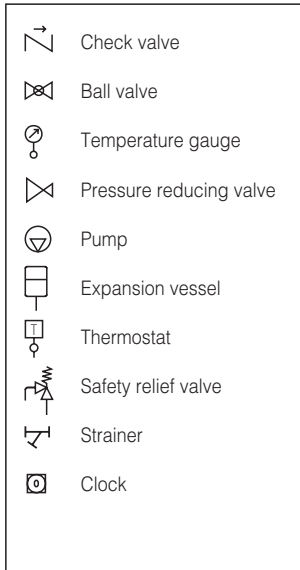

LEAVE THIS MANUAL AS A REFERENCE GUIDE FOR THE USER.

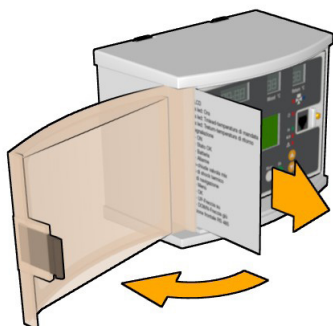

The user quick guide is inserted in the special compartment provided in the left part of the power unit.